

90-4712

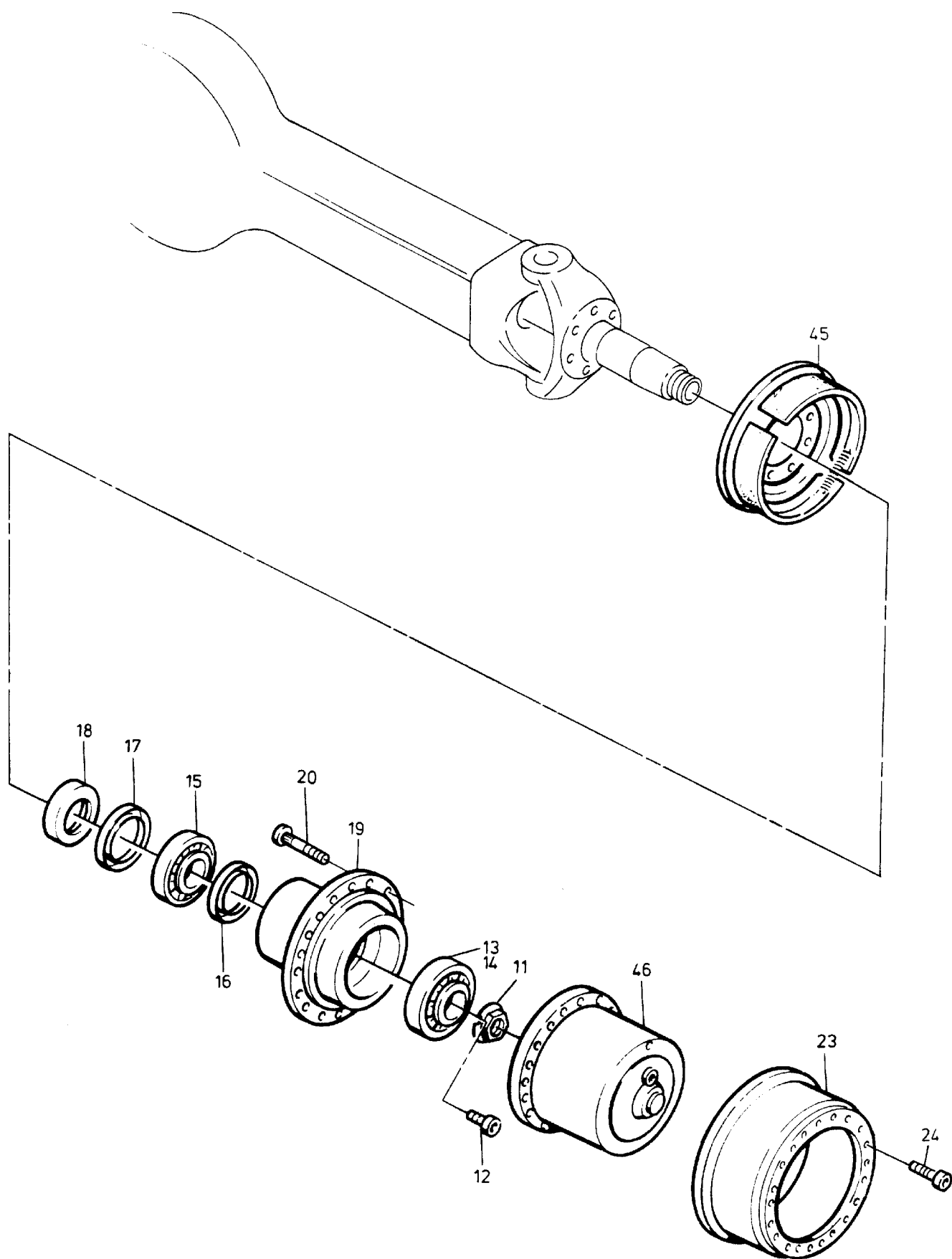

90-4712

Seite/Page 2 / 3

Bild-Nr Fig Fig Fig Fig Bild nr	ET-Nr Part-No No. de Piece No. de Pieza No. del Pezzo Detalj nr	Stückzahl Qty Qte Ctd Qta Antal		Gegenstand Description Designation Descripcion Designazione Benaemning
00	416 763 40	1	Lenktriebachse, kpl.	Steering drive axle, assy.
01	771 372 00	1	Achsgehäuse	Axle housing
02	313 268 99	1	Verschlußschraube	Screw plug
03	340 243 99	1	Dichtring	Seal ring
04	313 396 99	1	Verschlußschraube	Screw plug
05	339 714 99	1	Dichtring	Seal ring
06	688 294 00	2	Gelenkwelle	Joint shaft
08	500 215 98	8	Dichtring	Seal ring
09	500 213 98	6	Sprengring	Snap ring
10	500 191 98	4	Nadellager	Needle bearing
11	997 415 00	2	Wellenmutter	Nut
12	350 362 99	4	Schraube	Screw
13	957 340 00	2	Kegelrollenlagerinnenring	Tapered roller bearing cup
14	957 339 00	2	Kegelrollenlageraußenring	Tapered roller bearing cone
15	363 167 99	2	Rollenlager	Roller bearing
16	006 749 98	2	Dichtring	Seal ring
17	500 200 98	2	Dichtring	Seal ring
18	956 082 00	2	Abstandsring	Spacer ring
19	965 958 00	2	Radnabe	Wheel hub
20	965 729 00	20	Radbolzen	Wheel bolt
23	965 730 00	2	Bremstrommel	Brake drum
24	320 363 99	4	Schraube	Screw
26	771 380 00	1	Spurhebel	Lever
27	771 381 00	1	Spurhebel	Lever
28	771 382 00	1	Spurhebel	Lever
29	308 417 99	20	Schraube	Screw
31	771 377 00	1	Deckel	Cover
32	307 839 99	3	Schraube	Screw
33	350 562 99	4	Schmiernippel	Fitting
34	999 852 00	1	Spurstange	Steering track rod
35	956 139 00	2	Lagerbuchse	Bush
36	356 140 00	2	Anlaufscheibe	Stop washer
37	965 954 00	2	Achsschenkelbolzen	Steering knuckle pin
38	956 142 00	2	Lagerbuchse	Bush
39	956 143 00	2	Achsschenkelbolzen	Steering knuckle pin
43	965 767 00	1	Achsschenkel	Steering knuckle
44	999 858 00	1	Achsschenkel	Steering knuckle
45	-	2	Bremse siehe EL-Blatt 90-3951	Brake see page 90-3951
46	-	2	Planetengetriebe siehe EL-Blatt 90-4612	Planetary gear see page 90-4612
47	-	1	Achsantrieb siehe EL-Blatt 90-2510	Axle drive see page 90-2510

Lenktriebachse
Steering Drive Axle

90-4712

Seite/Page 3 / 3