

993-0961a

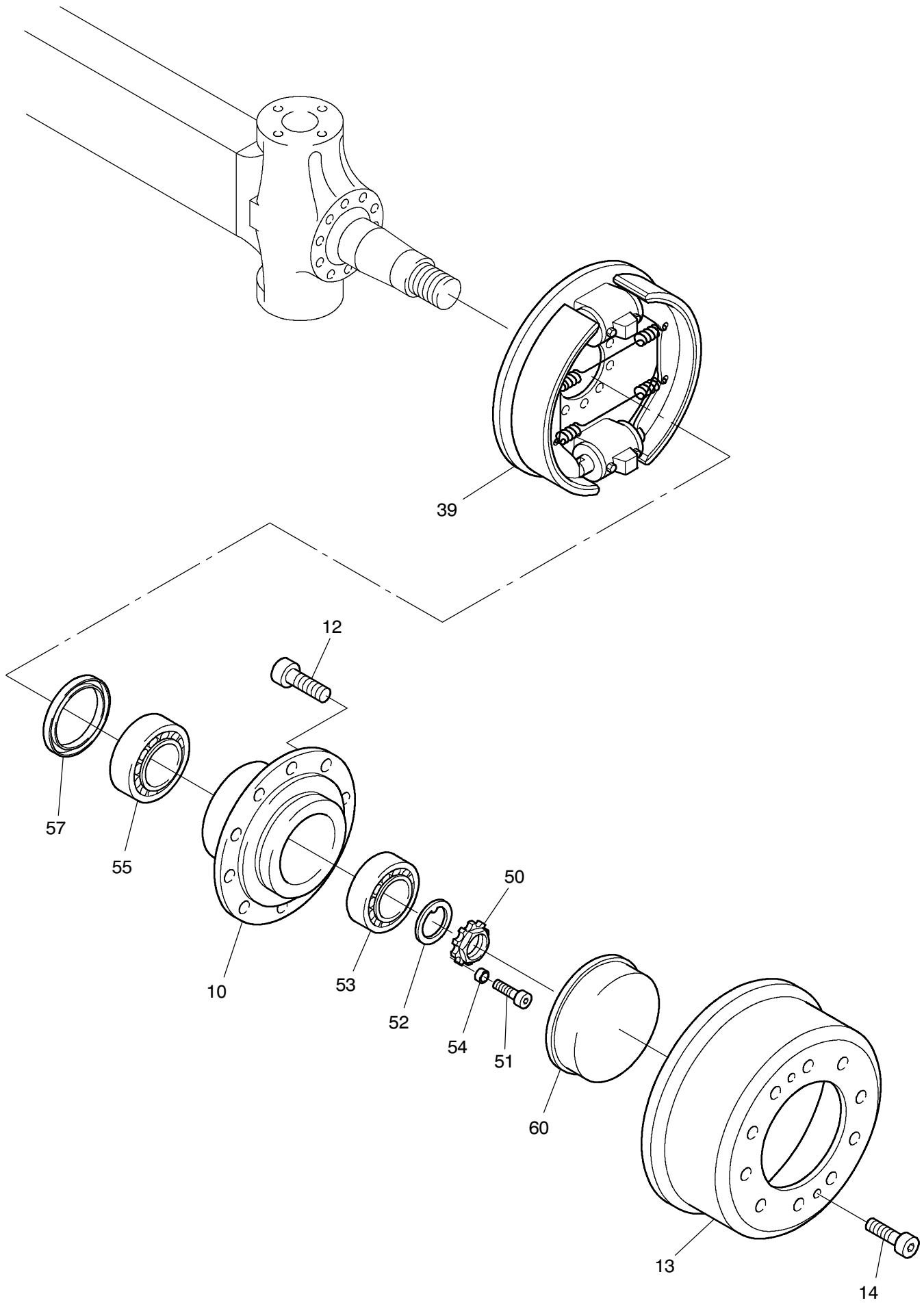

993-0961a

Bild-Nr Fig Fig Fig Fig Bild nr	ET-Nr Part-No No. de Piece No. de Pieza No. del Pezzo Detalj nr	Stückzahl Qty Qte Ctd Qta Antal		Gegenstand Description Designation Descripcion Designazione Benaemning
00	122 081 12		Lenkachse	Steering axle
01	400 653 12	1	Achsgehäuse, kpl.	Axle housing, assy.
10	763 078 73	2	Radnabe	Wheel hub
12	780 787 73	20	Radbolzen	Wheel bolt
13	779 925 73	2	Bremstrommel	Brake drum
14	350 368 99	4	Zylinderschraube	Bolt
15	319 305 99	4	Zylinderschraube	Bolt
16	350 564 99	2	Kegelschmierkopf	Grease nipple
17	400 654 12	1	Hebel, links	Lever, l.h.
18	400 655 12	1	Hebel, rechts	Lever, r.h.
19	400 656 12	1	Hebel,, links	Lever, l.h.
20	307 615 99	12	Schraube	Bolt
21	350 385 99	3	Zylinderschraube	Bolt
22	771 047 00	1	Deckel, rechts	Cover, r.h.
23	511 416 98	2	O-Ring	O-ring
24	350 562 99	2	Kegelschmiernippel	Fitting
25	319 301 99	8	Zylinderschraube	Bolt
26	763 203 73	1	Spurstange	Steering track rod
27	770 523 00	2	Lagerbuchse, unten	Bush, lower
28	965 719 00	2	Anlaufscheibe	Stop washer
29	400 088 12	2	Buchse	Bushing
30	780 500 73	2	Buchse	Bushing
31	772 366 73	2	Achsschenkelbolzen	Steering knuckle pin
32	780 163 73	2	Anlaufscheibe	Stop washer
33	771 284 00	2	Federbock	Spring block
34	319 311 99	2	Zylinderschraube	Bolt
35	345 629 99	2	Zylinderstift	Parallel pin
36	400 078 12	2	Achsschenkel	Steering knuckle
37	777 331 73	2	Schraube	Bolt
38	320 112 99	2	Mutter	Nut
39	401 053 12	2	Bremse siehe EL-Blatt 993-1195	Brake see page 993-1195
50	997 415 00	2	Wellenmutter	Shaft nut
51	509 633 98	2	Zylinderschraube	Screw
52	400 079 12	2	Nasenscheibe	Slotted cone washer
53	361 580 99	2	Kegelrollenlager	Taper roller bearing
54	777 094 73	2	Buchse	Bushing
55	534 023 99	2	Kegel - Rollenlager	Taper roller bearing
57	400 528 12	2	Wellendichtring	Shaft seal
60	760 675 00	2	Deckel	Cover

**Achse 6
Axle 6**

993-0961a

Seite/Page 3 / 3